

# BLH-HPDX型

## ■寸法表 (mm)

### BLH-HPDX-PS型

型番	A	B	C	吹出口
3600HPDX-PS	1490	1450	450	#14×3
4800HPDX-PS	1680	1640	550	#16×3
6000HPDX-PS	2010	1970	"	"

●騒音値はP16をご参照ください。

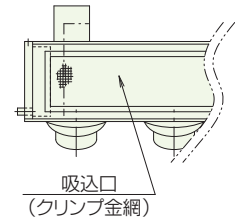
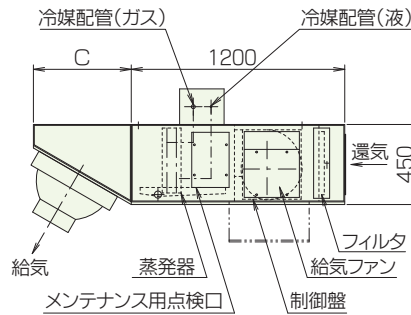
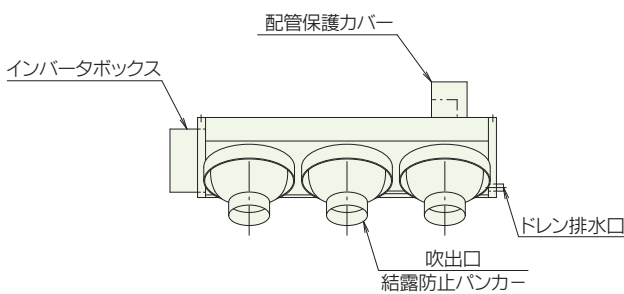
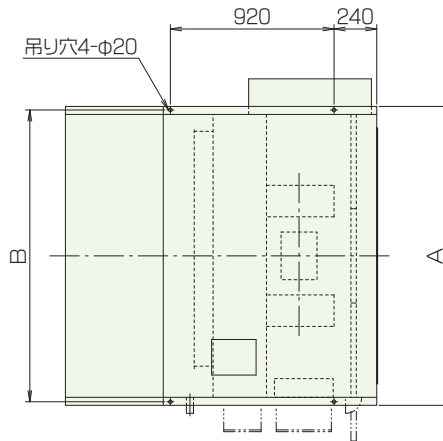

### BLH-HPDX-PF型

型番	A	B	C	吹出口
3600HPDX-PF	1490	1450	450	#14×3
4800HPDX-PF	1680	1640	550	#16×3
6000HPDX-PF	2010	1970	"	"

●騒音値はP16をご参照ください。

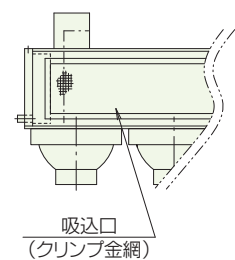
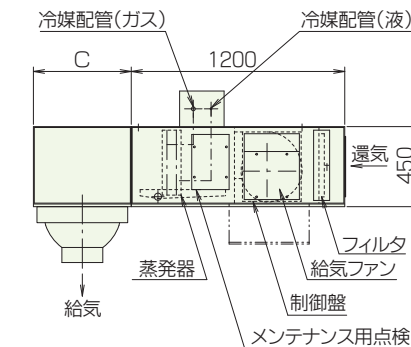
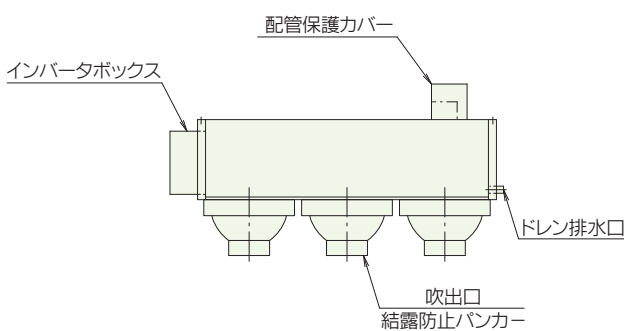
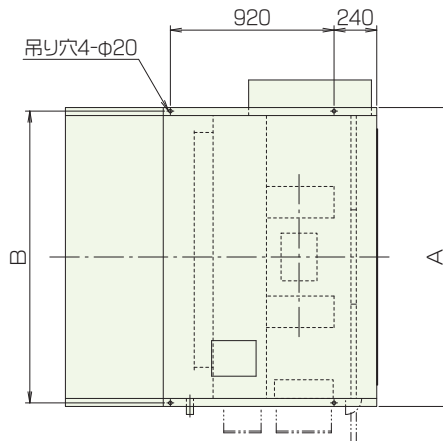

# BLH-HPSE型

## ■寸法表 (mm)

### BLH-HPSE-PS型

型番	A	B	C	吹出口
3600HPSE-PS	1490	1450	450	#14×3
4800HPSE-PS	1680	1640	550	#16×3
6000HPSE-PS	2010	1970	"	"

●騒音値はP16をご参照ください。

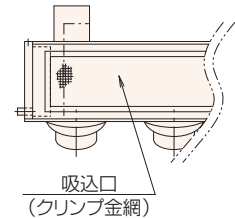
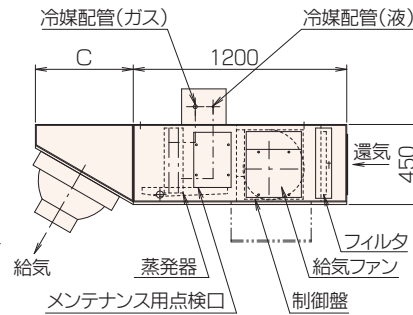
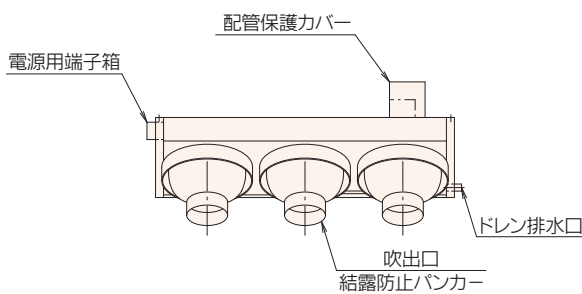
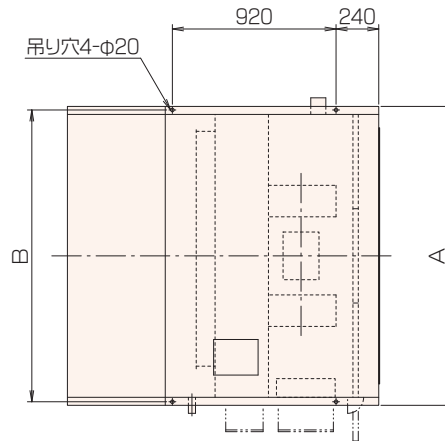

### BLH-HPSE-PF型

型番	A	B	C	吹出口
3600HPSE-PF	1490	1450	450	#14×3
4800HPSE-PF	1680	1640	550	#16×3
6000HPSE-PF	2010	1970	"	"

●騒音値はP16をご参照ください。

