

4管式

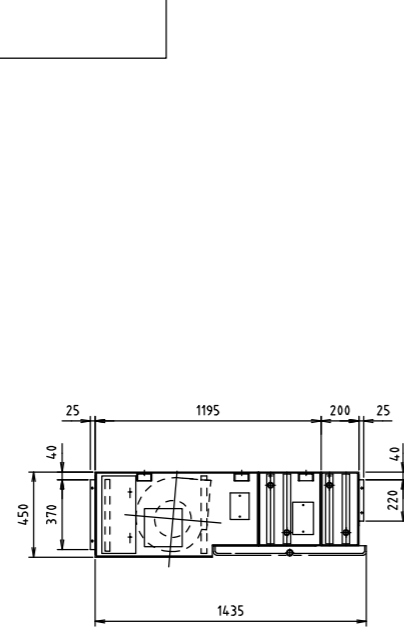

SCH2-1200ZW2

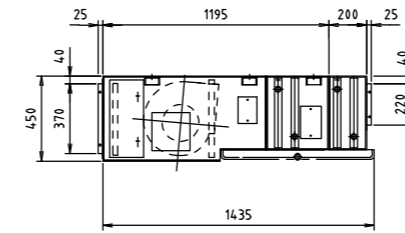
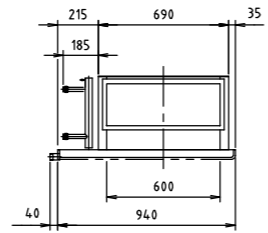
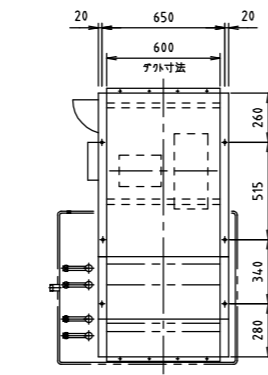

SCH2-3600ZW2

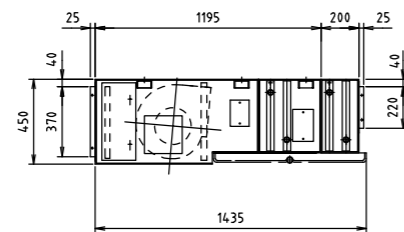
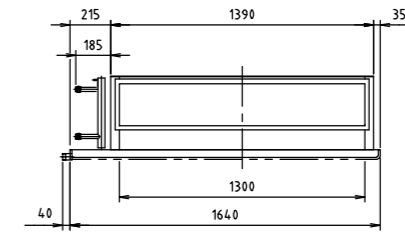
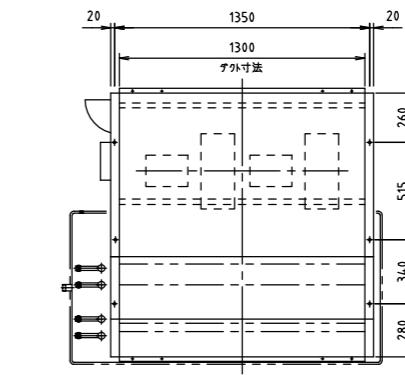

SCH2-1800ZW2

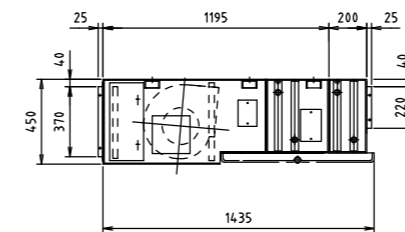
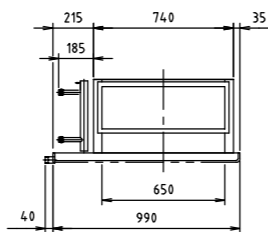
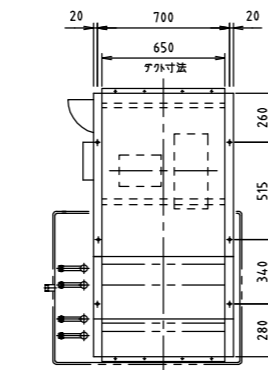

SCH2-4800ZW2

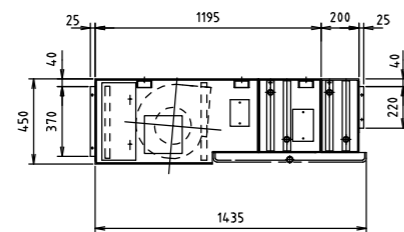
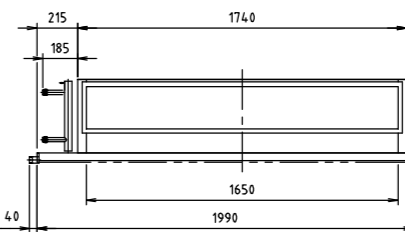
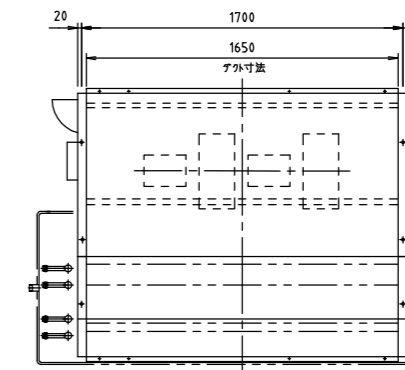

SCH2-2400ZW2

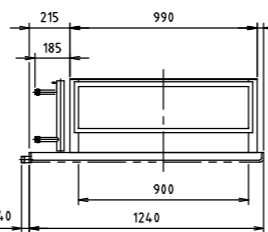
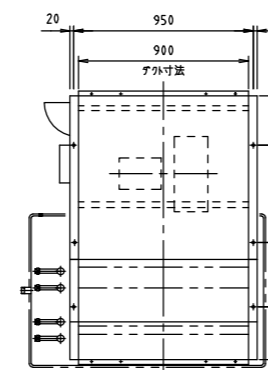

1. 各型番の外形寸法を示します。
2. 本図は左配管用を示します。
3. 詳細は承認図を参照して下さい。

品名	天埋大容量形ファンコイル工外			御得意先	殿
	SCH2-ZW2			納入先	殿
営業確認	照査	検図	作成	図面番号	
			単位 mm	尺度 1/40	<b>木村工機株式会社</b>